

Pure Jatropha Oil for Power Generation on Floreana Island/Galapagos: Four Years Experience on Engine Operation and Fuel Quality

Georg Gruber

Vereinigte Werkstätten für Pflanzenöltechnologie Dr. Gruber/Gruber GbR (VWP-Gruber), Allersberg D-90584, Germany

Received: November 21, 2013 / Accepted: January 23, 2014 / Published: May 31, 2014.

Abstract: In the small country of Ecuador, all environmental risks of the production and consumption of fossil fuels can be observed by damages through oil exploration in the amazonite rainforest and two tank ship accidents close by Galapagos Islands causing death of 10,000 marine iguanas and other species. Now Ecuador plans to replace all environmentally dangerous diesel generators from all four inhabited Galapagos Islands by a hybrid system using 100% renewable energy for electricity production. Since 2010 a hybrid system of two Jatropha oil generators with an electrical power of 69 kW (kW_{el}) and a photovoltaic plant with an electrical peak power of 21 kW (kW_{peak}) is successfully providing electricity from renewable energy for inhabitants and tourists of Floreana Island. After more than 15,000 engine operation hours of each engine there is no engine defect. For fuel supply, the so-called “Living Fence” concept collecting Jatropha seeds by farmers and families from already existing 6,000 km hedges on Ecuadorian mainland was chosen to comply with highest biofuel sustainability standards. The Jatropha oil is produced in a decentralized so-called CompacTropa oil mill container following the ambitious German fuel quality standard DIN51605. Since 2010 Floreana project successfully demonstrates that it is possible to replace diesel gen sets by generators fueled with pure Jatropha oil from decentralized sustainable production.

Key words: Jatropha oil, power generation, off grid, hybrid system, sustainable biofuel, plant oil engines, pure vegetable oil.

1. Introduction

Fossil fuels through all stages of exploration, processing, transportation and consumption are causing damage to water, land and air. The Galapagos archipelago as symbol for the theory of evolution is especially vulnerable to all negative effects of fossil fuels. Climate change, rising sea level, shifting ocean streams and the danger of oil spills from ship accidents and marine traffic make Galapagos and its unique eco system and marine life to a multiple target.

In 2001/2002, two oil spills from tank ships Jessica and Taurus threatened Ecuador’s Galapagos Islands (Fig. 1).

Over 10,000 marine iguanas and other species died as a result of over 150,000 gallons of diesel fuel spilled

into the sea off shore Galapagos.

At about the same time, the public was alarmed by information about environmental damages caused by US based oil companies Texaco/Chevron drilling for oil in the Ecuadorian Amazonas area. Fig. 2 gives an example of serious ecological problems that oil development created for water, soil and the indigenous population whose cancer cases increased dramatically due to the widespread oil pollution of soil and drinking water resources [1].

In 2011, Chevron was sentenced by an Ecuadorian court to pay 19 billion US-\$ in damages to Amazonian residents [2].

As a result of the multiple environmental risks in 2007 UNESCO (United Nations Educational, Scientific and Cultural Organization) put the Galapagos Islands on their list of World Heritage in Danger.

Corresponding author: Georg Gruber, Ph.D., research fields: engine development, sustainable bio fuels, bio fuel quality standarts. E-mail: g.gruber@vwp-europe.com.

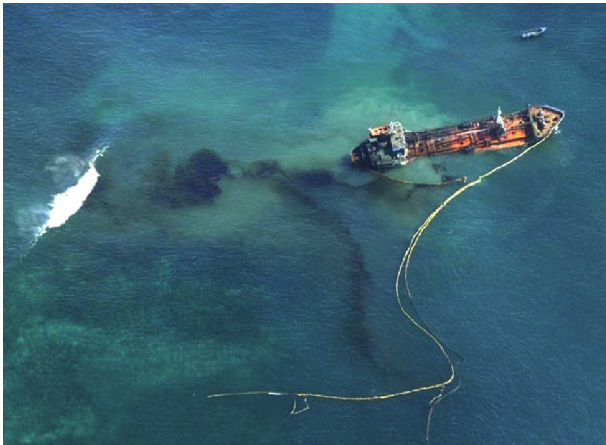

Fig. 1 Sunken Jessica at Galapagos Islands.



Fig. 2 Oil pollution in Ecuador, Lago Agrio, 2007.

To conserve this World Heritage site, in the same year the “Zero Fossil Fuel Initiative for Galapagos Islands” was started by the Ecuadorian Government. It is presumably the most important worldwide project to totally release an archipelago of about 25,000 inhabitants and more than 150,000 tourists every year from the usage of fossil fuels for electricity and mobility.

Fig. 3 shows a time frame and different renewable energy paths for Galapagos Islands to substitute diesel fuels until 2020. From 2007 to 2020, it is the intention to replace the 100% diesel consumption for electricity production, mobile transportation and marine traffic completely with a mix of solar,-wind energy and pure plant oil from Jatropha.

Fig. 4 gives a survey about all different renewable energy hybrid systems planned to replace the so far only used diesel generators on the four inhabited islands.

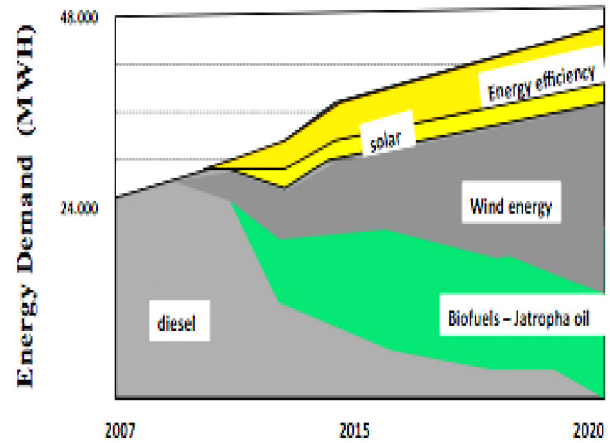

Fig. 3 Substitution of fossil fuels till 2020.



Fig. 4 Different renewable energy hybrid systems for Galapagos Archipelago.

On any island, the implementation of biofuel operated generators is included to provide electricity in a reliable and adjustable way, stabilize the grid and together with a battery balance the fluctuating character of PV (photovoltaic) and wind energy.

Having the whole range of environmental damages of crude oil in Ecuador in mind, the purpose for the substitution of crude oil is to meet highest ecological standards for both the consumption of biofuels in the engine and their production in a fully sustainable agricultural practice. It would not make any sense to leave out the risks of fossil fuels to the Amazonas and replace them with similar risks from the production of biofuels like cutting rainforest or exploiting and/or poisoning water resources by intensive consumption of chemicals in agriculture.

In 2008, the “DED (German Development Service) (Deutsche Entwicklungsdienst)” together with the German Company VWP-Gruber conducted a study for the ideal integrated biofuel concept for whole Galapagos archipelago [3].

Out of different biofuels (biodiesel, pure plant oil, biogas/woodgas) and different plant oils (palm, rapeseed, *Jatropha*, sunflower, soy) pure *Jatropha* oil was chosen with the best environmental, social and economical balance.

2. Floreana’s Concept for a Sustainable Production of Electricity and *Jatropha* Fuel

With about 200 residents and a few thousand tourists per year, Floreana is the smallest of the four inhabited Galapagos Islands. The concept was to combine the already existing 21 kW_{peak} photovoltaic and battery bank with new generators working with *Jatropha* oil and a sustainable fuel production process. It was also the concept to use Floreana as a pilot project and model for the upcoming bigger Galapagos Islands to gain experience in engine operation and fuel production.

The pilot project was supported and financed by the German Federal Ministry for Environment, Nature Conservation and Nuclear Safety (BMU-Klimaschutz-initiative “Erneuerbare Energien Galapagos”), the Ecuadorian MEER (Ministry for Energy and Renewable Energy) and the German GIZ (German Technical Cooperation) (Gesellschaft für Internationale Zusammenarbeit GmbH) [3].

The project lasted over three years from 2010 until end of 2013. In the following, a report about the technical concept, emissions and technical performance will be given.

2.1 Technical Energy Hybrid Concept

On Floreana Island, 100% solar energy is used by combining photovoltaic and photosynthesis. The 21 kW_{peak} PV is harvesting the actual solar radiation during the day while two 69 kW_{el.} generators using *Jatropha* oil as stored solar energy are building the grid

and add electricity for peak electricity demand or for periods with no solar light or empty batteries.

Such pure plant oil generator/photovoltaic/battery hybrid systems for off-grid application already have been used in 1993 for the first time at alpine huts of the German Alpine Association [4]. Up to now more than 50 hybrid systems with pure canola oil generators or CHP together with other renewable energy technologies are successfully operated by the German Alpine Association.

The generators on Floreana are designed to use 100% *Jatropha* oil as fuel but also diesel or any blend between *Jatropha* oil and diesel.

Fig. 5 shows the graphic of the AC (alternating current) hybrid concept on Floreana.

The challenge on Floreana was to establish a 100% renewable energy off-grid system whose electricity supply exactly covers the electricity demand of a constantly shifting 24 hours’ daily load curve of Floreana Island. Comparable to the frame conditions of remote huts in the Austrian and German Alps also the island situation of the Galapagos archipelago offers no safety or backup system from a coal/nuclear energized public grid. There are different scenarios and concepts for hybrid system operation to achieve highest PV penetration and lowest engine hour operation at low operational cost.

Fig. 6 is the example of a scenario how the electricity demand over 24 h (red curve) can be satisfied by the interaction of PV supply (yellow), *Jatropha* oil gen-sets (blue) and charging/discharging batteries (green).

The not usable PV share (grey) can be used for a growing electricity demand in the future or for battery charging of electrically operated vehicles or boats. The hybrid system of Fig. 6 will be installed on Floreana in 2014 to replace not repairable and broken inverters and battery bank of the old photovoltaic installation.

2.2 Sustainable Decentralized *Jatropha* Oil Production by the “Living Fence Concept”

For any substitution of fossil fuels for biofuels, it is

Pure Jatropha Oil for Power Generation on Floreana Island/Galapagos: Four Years Experience on Engine Operation and Fuel Quality

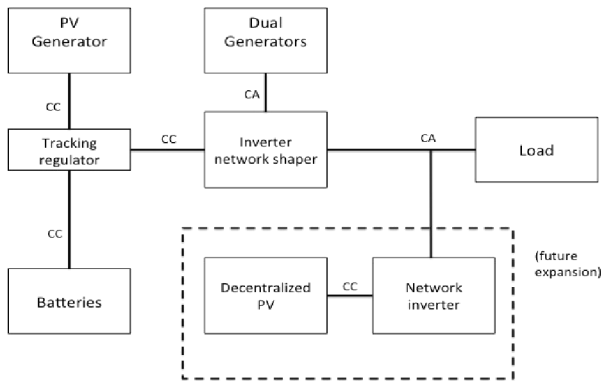

Fig. 5 Energy hybrid concept on Floreana [5].

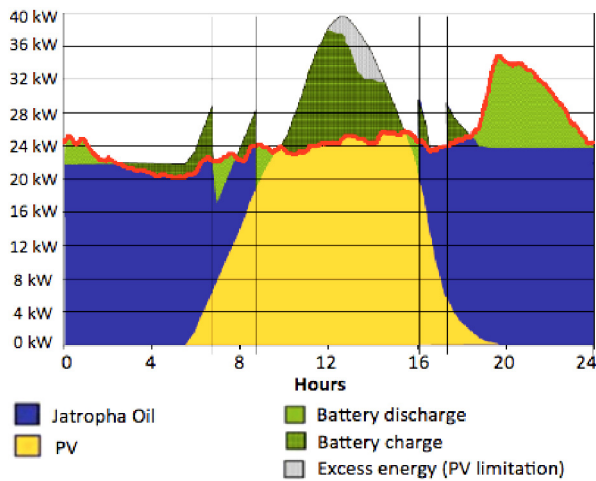

Fig. 6 Simulation of Floreana hybrid concept [5].

important to not only be favourable on the production of electricity (engine performance, emissions) but also on the production of the fuel. Due to the specific island situation of Galapagos, experts are afraid of invasive species. This was the reason to not grow Jatropha directly on the islands in closed CO₂ and energy cycles without transportation need but on the Ecuadorian mainland (Fig. 7).

In the following, the “Living Fence Concept” will be described.

The production of biofuels is not automatically environmentally friendly. Terms like “fuel versus food”, destroying of rain forest, monocultures, genetic engineering, land crabbing indicate a multiple negative impact of biofuels production to environment and social welfare.

Jatropha oil as fuel and especially its production



Fig. 7 Jatropha oil production in Manabi/Ecuador.

from living fences avoids all of these negative effects.

In Ecuador, over 6,000 km already existing Jatropha hedges are reported which traditionally fence off pasture land [3]. With financial support of the German BMU (Federal Environment Ministry), a Jatropha oil production concept was established to provide the fuel for the two existing generators on Floreana and the new generators on Isabela which are planned for end of 2014.

The project is located in the coastal province of Manabi, one of the country’s poorest regions. Local small-scale farmers are consulted and trained in all aspects of Jatropha oil production.

Figs. 8 and 9 show a local family collecting Jatropha nuts from old hedges and farmers transporting the seed material in sacs with their donkeys to the next community centre to weigh and sell it.

3. Results on Engine Operation and Jatropha Oil Production

Since worldwide there existed no experience on operating an off grid photovoltaic/battery hybrid system with direct injecting diesel engines of bigger



Picture: Margarita Baquero

Fig. 8 “Living Fence” family harvesting.



Picture: Margarita Baquero

Fig. 9 CO₂-free seed transport in Manabi, Ecuador.

size with pure Jatropha oil it was important to learn about all problems on Floreana before the more than 10 times bigger installation of the same hybrid concept started at Isabela Island. This also included any experience to gain on producing and improving the fuel quality of Jatropha oil including aspects of transportation and storage.

3.1 Engines Operation Experience

By the end of 2010, two dual fuel generator started electricity production. The engines are able to run with diesel, 100% pure Jatropha oil or with any blend of both fuels.

Due to a higher viscosity, flame point and lower

cetane number of Jatropha oil in comparison to diesel fuel it is necessary to adapt regular serial diesel engines to pure plant oil as fuel. The following patent protected modifications have been made:

fuel detection system for heating pure plant oil but cooling diesel;

- powerful fuel system with adaptations in power, size and material of fuel pumps, fuel lines, valves;
- new combustion process with adapted injection beam positioning;
- modification of injection nozzles;
- modification of intake and outlet valves.

Figs. 10 and 11 illustrate the 21 kW_{peak} photovoltaic and the two 69 kW_{el.} generators after installation in 2010.



Fig. 10 Photovoltaic on Floreana.



Fig. 11 Jatropha gen-sets 2 × 69 kW_{el.} on Floreana.

From 2010 to end of 2013, the two generators have been operated over 13,000 h each. Due to a major defect of the photovoltaic, the engines have been long-time operated 24 h/day.

In 2014, the photovoltaic is planned to be repaired again then with an expected engine operation hours of 4,700 h/year.

The engines have been fuelled with 100% pure *Jatropha* oil, 100% diesel and with *Jatropha*/diesel blends. The patented engine technology of injectors, combustion system, fuel detection system, valve guide did not show any single defect although the engines for a long-time have been operated with a fuel quality which did not comply with the required DIN V 51605.

The project was attended by a three years' monitoring, maintenance and training program for the local operators by VWP-Gruber and their local joint-venture partner Proviento S.A. Such training programs are of highest priority if it is planned to provide remote islands with high end equipment and complex hybrid systems.

The electricity provider for whole Galapagos archipelago, Elecgalapagos, and its local engine operators improved a lot in their knowledge and skills for fuel quality, maintenance, failure forecast, etc..

As an example for plant oil fired engines, it is very important to not exceed the required interval for changing the engine lubrication oil.

Fig. 12 illustrates the engine oil changing interval of generator 2 from 4,500 h to 10,000 h. Assuming a required maintenance of first 250 h (red line) and later 200 h (green line), the curve of the conducted engine oil change demonstrates many critical oversteps of the interval in the beginning. After many training lessons the local operators respected the set interval to avoid engine damage due to overstepped engine oil intervals.

3.2 Emissions of *Jatropha* Oil Engines

Although *Jatropha* oil is considered as one of the most promising future fuels, there are almost no references for pure *Jatropha* oil on long term engine

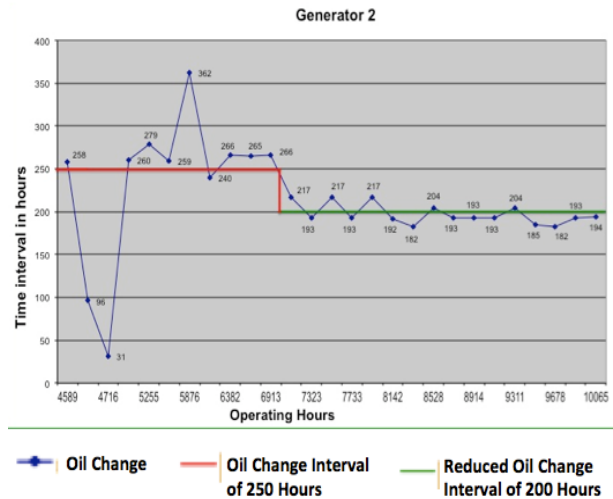

Fig. 12 Engine oil change intervals of generator 2 [6].

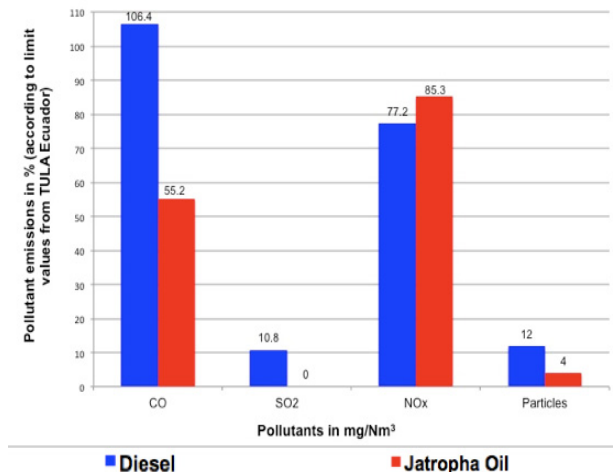

Fig. 13 Emissions of Floreana engines with diesel and *Jatropha* fuel.

behaviour or emission results.

In Fig. 13, the emission test results of the modified Deutz 1,013 Bf4M engines for dual fuel operation are displayed.

The emission test was conducted in January 2011 with a TESTO 350 M/XL emission tester [7].

With the exception of a 5% exceeding of the CO emission limit in diesel operation, all other emissions for *Jatropha* and diesel operation clearly fulfilled the required local emission standard for Galapagos. Basically, CO and particle emissions of *Jatropha* are half of the emission in diesel mode (particulate emissions have been calculated). Regarding *Jatropha*, emission for sulphur is zero because there is practically

almost no sulphur in *Jatropha* oil. Due to a faster combustion, the NO_x emissions of *Jatropha* oil is about 10% higher than with diesel fuel but still below the required limit for NO_x.

In total, in case of mechanically operated and modified direct injection engines, the emissions for pure *Jatropha* oil are favourable to the emission results with diesel fuel.

3.3 Sustainability Aspects of *Jatropha* Oil

When replacing fossil fuels with biofuels it is important to improve the CO₂ footprint of the biofuel production to the highest extend. Also, any economical and agricultural conflict with food production should be avoided. To increase the yield and reduce the cost of biofuels many times monocultures with a high consumption of fuel, chemicals, water resources are established on most valuable farm land or even in midst of rainforest area financing the new biofuel plantation with sold wood from the cut down rain forest. Large scale biofuel production very often also is connected with land grabbing and defiance of social or labour rights.

The concept of the *Jatropha* oil production in Manabi with decentralized oil mills owned by the community and using "Living Fences" aims at the local farmer families to start a cooperation which adds continuously income by selling *Jatropha* oil to Galapagos Islands [8]. As non-edible oil, *Jatropha* oil avoids the food versus fuel conflict. Since existing hedges are used and maintained, no additional agricultural land or rainforest nor chemicals or irrigation is necessary. In total, already 3,000 persons at 52 community gathering points are integrated into the *Jatropha* oil production concept for Galapagos Islands [9].

Overall, the *Jatropha* oil production cooperative from Manabi complies with all economical, social and ecological sustainability criterions. In the next steps the price of about \$8/galone shall be reduced. A reduction of CO₂ almost to a closed CO₂ cycle is possible if *Jatropha* is grown directly on Galapagos Islands saving cost and energy for the transport from

Manabi to Galapagos and using the CO₂ neutral electricity of the local power generation for the oil production.

3.4 Results on Fuel Quality

Beside sustainability factors, it is also necessary that the *Jatropha* oil from Manabi fulfils specific fuel quality requirements.

Jatropha oil for Galapagos Islands will be used in Floreana for dual fuel Deutz d.i. engines and from 2014 on at Isabela in high pressure injection common-rail engines. Especially the common-rail engines require a first class fuel. The fuel quality which has to be achieved is set by the so-called DIN51605 [10].

Attempts in 2010/2011 to use local oil pressing equipment generated mostly a bad fuel quality and oil deprivation in pressing and filtering. To enhance oil recovery, GIZ ordered a turn-key CompacTropa oil press container accompanied by a two years' R & D (research and development) program from VWP-Gruber to improve the oil quality of *Jatropha*.

Fig. 14 illustrates the CompacTropa oil press container which was delivered in 2012.

Using the example of about 600 decentralized oil mills in Germany, the CompacTropa together with a special purification device is a standardized decentralized oil mill mounted in a 20 feet container. With standardized oil mill technology and purification systems single fuel processing units are able to produce different plant oil fuels with the same high quality at reduced investment cost.

Besides a Reinartz oil press, oil tanks and a chamber filter unit also a purification system is integrated to reduce P (phosphorous), Ca (calcium) and Mg (magnesia) to the limits of DIN51605. This patented VWP/Waldland purification process is described in Fig. 15.

The challenge is to reach a high press efficiency and oil quality out of a bad seed quality in Manabi. The P, Ca/Mg content in the *Jatropha* seeds is very high because the rural families and farmers are harvesting from the old "Living Fences" all *Jatropha* nuts from unripe, mature to over-mature.



Fig. 14 CompacTropa oil mill in Manabi.

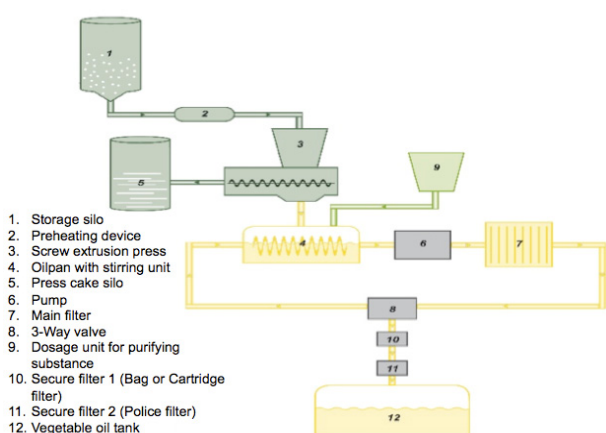

Fig. 15 VWP/Waldland process for P/Ca/Mg cleaning.

For P, Ca/Mg cleaning, first a specific mixture of OBEFIL (organic bleaching earths) has to be stirred into the crude oil tank located after the oil press.

Depending on the initial value of P, Ca/Mg in the crude oil and the desired reduction value in the clean oil, a particular combination of OBEFIL dosage, stirring time, oil temperature and filtering effort is needed to reach DIN51605 quality.

The reduction of ash building elements to DIN51605 limits is necessary to avoid reduced fuel filter intervals and engine fouling on piston/piston rings, injectors and valves caused by P, Ca/Mg.

Together with the extensive filtering process, also the contamination of Jatropha oil is improved and prohibits engine stops by contaminated fuel pumps/fuel filters or fuel lines.

The CompacTropa oil mill together with the

VWP/Waldland purification system is able to reach an oil press efficiency of 30%. This leads to 30 kg oil from 100 kg seeds although the seed material contains a lot of non-oil bearing substances like straw or nut shells or is partly eaten up by different insects.

The water content can exceed the limit due to in this poor area missing expensive seed drying and storage facilities.

P, Ca, Mg can be reduced to the analytical limit of detection which is 0.5 mg/kg each.

Only the acid content of Jatropha oil from “Living Fences” is very high because of the various Jatropha nuts with different stages of maturity which grow on the existing 6,000 km Jatropha hedges. To reduce the typically 2-3 times higher acid content of seed material from “Living Fences” in comparison to the DIN 51605 limit, it is necessary to improve the agricultural part. This includes maintenance of the “Living Fences” to produce a high degree of just mature seed material and improved harvesting and storage conditions for seed and oil.

3.5 Fuel Transport, Logistic and Storage

Based on the high energy density of Jatropha oil, the energy efficiency for fuel transport is the same as with diesel. As incombustible and non-explosive natural product with water hazard class zero, Jatropha oil is the ideal liquid fuel for transport and storage on Galapagos Islands without any risks known from Diesel.

With 1,000 L ICB (International Bulk Containers) Jatropha oil is shipped from Ecuadorian mainland about 1,000 km to the Galapagos archipelago. Fig. 16 demonstrates the unloading process on Floreana.

From a sea-worthy cargo ship (in the background), the IBCs are lifted on a wooden barge which is pushed from a small boat into the harbour. With a crane truck donated from BMU/GIZ the full IBCs are unloaded and driven 1 km to the storage tank of the generator house.

The fuel depot on Floreana (Fig. 17) was especially constructed to avoid a fast quality deprivation of the natural fuel. Direct exposure to sun and oxygen, heat

and, water have a negative impact on fuel quality of pure plant oil fuels.



Fig. 16 Jatropha oil transport to Floreana.



Fig. 17 New fuel depot on Floreana.



Fig. 18 IBC return transport to Manabi.

Vertically designed and white painted big steel tanks which are sun protected by a roof and non-ferrous material in the pipe and pump system prevent the natural product Jatropha oil from a fast oil quality decrease in the hot and for plant oil storage unfavourable environment of Galapagos.

For safety reasons and to ensure the Floreana generators the same oil quality like it was in Manabi, an organic additive is mixed periodically into the oil to keep the oxidation stability over the mandatory DIN51605 limit of 6 h [10].

The empty 1,000 L IBCs are transported back to Manabi at the next possible moment (Fig. 18).

Altogether, the complex fuel logistic from the province of Manabi to the remote island of Galapagos archipelago works very well. The latent risk from transport and storage of diesel fuel is completely vanished when pure Jatropha oil is used.

4. Conclusions

The goal of the Ecuadorian Government to substitute the fossil energy supply of Galapagos Islands with 100% renewable energy until 2020 is one of the most ambitious initiatives worldwide on this sector.

Based on a study from 2008, the pilot project Floreana was established and has been in operation already for more than three years now. The integrated biofuel/Jatropha oil concept of modified dual fuel generators on Floreana/Galapagos, a sustainable Jatropha oil production on the Ecuadorian mainland and a safe and functional fuel transport logistic and storage is fully developed and can be scaled up at the more than 10 times bigger Isabela Island [11]. After reactivation of the existing PV plant, Floreana is the world's first marine island which is fully supplied by a 100% renewable energy hybrid system.

Floreana Island in this respect is a technically evolutionary model not only for the other Galapagos Islands but for any other island or area in the world to achieve a 100% renewable energy supply.

Industrial promoted alternatives like 2% or 7%

blend strategies of biodiesel and diesel (B2 or B7) could not solve the risks from fossil fuels for Galapagos. 2nd or 3rd generation biofuels have not been available. But also other environmentally vulnerable areas than alpine huts or Marine Islands need 100% renewable energy solutions with pure biofuels instead of politically and industrial favoured blends between biofuels and fossil fuels.

Actually the widely discussed “Energiewende” in Germany has the same framework conditions like an alpine hut or the remote Floreana Island. The experience made on Floreana Island therefore could also be useful for German energy demands.

The Galapagos Islands with their long history of evolution, however, seem to be one of the best places in the world to create blue prints of revolutionary technologies which are necessary for the transition from the terminated fossil age to an infinite renewable energy era.

The next challenge on Galapagos will be the substitution of fossil fuels for transportation vehicles and marine traffic which cannot be replaced technically by electrical concepts. Also for this mobility segment industry offers no solution which could help Galapagos to get rid of fossil fuels.

Acknowledgments

After more than four years of successful project cooperation, we want to thank Ecuadorian Ministry of Electricity and Renewable Energy (contracting entity), German GIZ (project coordinator), ELECGALAPAGOS S.A.(electricity provider at Galapagos Islands), ERGAL (Energia Renovable para Galapagos), IICA (Inter-American Institute for Cooperation on Agriculture), INIAP (Instituto Nacional de Investigaciones Agropecuarias), Öl- und Bioenergie GmbH (OBE Austria), Wellmann

Anlagentechnik GmbH and ProViento S.A.(local VWP project partner). Part-financing of this project by the German BMU is gratefully acknowledged.

References

- [1] D. Feige, Pursuing the polluters [Online], Los Angeles Times, <http://articles.latimes.com/2008/apr/20/opinion/op-feige20> (accessed Apr. 30, 2008).
- [2] P. Lo, Chevron sues its own shareholders in Ecuador compensation battle [Online], Corp Watch Blog, <http://www.corpwatch.org/article.php?id=15811> (accessed Jan. 24, 2013).
- [3] M. Hoffmann, R. Quintero, G. Gruber, Substitution of fossil fuels with biofuels for power generation at Floreana Island (Spanish), Quito/Ecuador, 2008.
- [4] G. Gruber, P. Weber, Pure plant oil and other renewable energies for alpine huts: On the razor's edge from fossil blaze to closed CO₂ and energy cycles (German), in: Alpine Forum for Environment and Economy, CIPRA Deutschland e.V., Siegsdorf, Germany, 1995.
- [5] A. Moreno, P. Carvajal, Simulation and analyses of the Floreana hybrid system on Galapagos (Spanish), Quito, Ecuador, 2013.
- [6] G. Gruber, Floreana Monitoring report X, 2/2013-4/2013, Allersberg, 90584, Am Steigbühl 2, 4.6.2013, S. 4.
- [7] A. Portilla, Results of Gaseous Emission Testing (spanish), report, National Technical Institute, Quito, Ecuador, Jan. 24, 2011.
- [8] GIZ, Climate protection through the use of renewable energies on the Galapagos islands , with special focus on power generation using Jatropha oil [Online], <http://www.giz.de/en/worldwide/12701.html> (accessed May 20, 2014).
- [9] P. Carvajal, MEER (Ministry of Electricity and Renewable Energy), Galapagos Islands Zero Fossil Fuel Initiative, Quito, Ecuador, May, 2012.
- [10] DIN51605-Fuels for Vegetable Oil Compatible Combustion Engines, German Institute for Norms and Standards (DIN), Berlin, Apr. 1, 2010.
- [11] Z. Bernhard, Experiences from German bilateral cooperation–IRENA [Online], IRENA (International Renewable Energy Agency), 2012, http://irena.org/DocumentDownloads/events/Malta_September2012/Bernhard_Zymla.pdf.